

Georg Fischer Waga N.V.

MULTI/JOINT® 3000 Plus DN50-DN400

INCH
2" - 16"

PAGE

18



+GF+



User Manual	GB
Montageanleitung	D
Montagehandleiding	NL
Manuel d'instruction	F
Brukermanual	NO
Användarmanual	SE
Montagevejledning	DK
Käyttömanuaali	FIN
Manual de instalacion	ES
Manual de instalação	PT
Manuale d'uso	IT
Manualul utilizatorului	RO
Návod k montáži	CZ
Εγχειρίδιο χρήσης	GR
Szerelési utasítás	HU
Руководство по установке	RUS
Instrukcja Obsługi	PL

Instructions in English, Dutch and German prevail.

Other languages informative only!

Georg Fischer Waga N.V.

Lange Veenteweg 19, 8161 PA, Netherlands

P.O. box 290, 8160 AG Epe, Netherlands

T +31 (0) 578 678 378 / F +31 (0) 578 620 848

waga.ps@georgfischer.com

www.waga.nl / www.multijoint.nl

© Georg Fischer Waga N.V.

2023, produced in the Netherlands

Közegészségügyi megjegyzés az 5/2023. (I.12.) Korm. rendelet szerint

Nyilvántartásba vétel/engedély száma: 28142-7/2020/KTEF

Alkalmazási terület: ivóvíz-ellátás

Maximális alkalmazási hőmérséklet: max 30 °C

***A termék megfelel az ivóvíz minőségi követelményeiről
és az ellenőrzés rendjéről szóló 5/2023. (I.12.) Korm.
rendelet előírásainak.***

OUR WEBSITES



CHECK TABLE IF CHOSEN FITTING MATCHES PIPE OD.

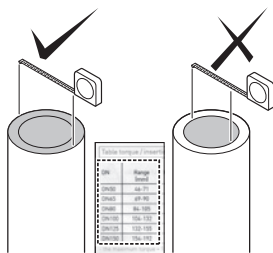

DN	Range (mm)
DN50	46-71
DN65	63-90
DN80	84-105
DN100	104-132
DN125	132-155
DN150	154-192

DN	Range (mm)
DN200	192-232
DN225	230-268
DN250	267-310
DN300	315-356
DN350	352-393
DN400	392-433

D Die Rohraussendurchmesser überprüfen und mit der Tabelle vergleichen.

NL Kies de juiste koppeling m.b.v. de tabel.

F Vérifiez sur le tableau si le raccord couvre bien le diamètre extérieur du tube.

NO Sjekk med tabell at koblingen stemmer overens med utvendig diameter rør.

SE Kontrollera om vald rördel stämmer mot rørets ytterdiameter.

DK Kontroller med tabellen om den valgte kobling passer til rørdiameteren.

FIN Tarkista taulukosta jos valitut asennukset sopivat putkelle QD.

PT Ver na tabela se os acessórios estão de acordo com o diâmetro exterior dos tubos.

ES Ver tabla anexa para unir distintos diámetros exteriores.

IT Controllare sulla tabella se il giunto è idoneo al d.e. del tubo.

GR Με βάση το πίνακα μεγεθών, επιβεβαιώστε ότι ο σύνδεσμος είναι κατάλληλος για τη συγκεκριμένη διάμετρο αγωγού στον οποίο πρόκειται να τοποθετηθεί.

CZ V tabulce zkontrolovat použitelnost tvarovky v daném rozsahu průměru.

HU Ellenőrizze, hogy a kiválasztott idom megfelel-e a cső külső átmérőjéhez.

RO Se verifica in tabel daca fittingul ales corespunde Dext al tevii.

PL Sprawdź w tabeli czy łącznik pasuje do zewnętrznej średnicy rury.

RUS Проверить по таблице совместимость фитинга с трубой.

02

DO NOT REMOVE OR GREASE BOLTS.

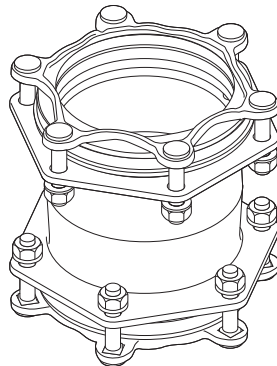
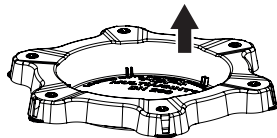
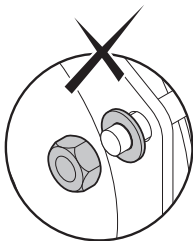
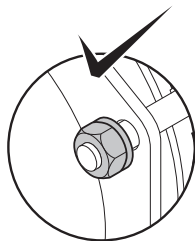
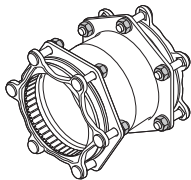

D Schrauben nicht entfernen und nicht fetten.

NL Bouten niet verwijderen en/of invetten.

F Ne pas enlever et/ou graisser les vis.

IT Non rimuovere e non ingrassare le viti.

03

CHECK IF 'FIKSERS' (METAL GRIPPERS) POSITION IS CORRECT.

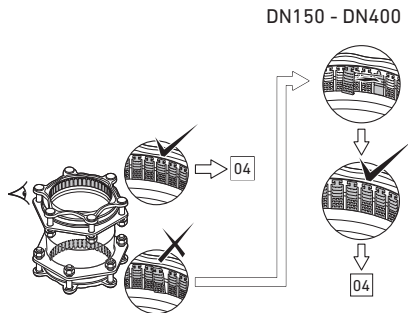
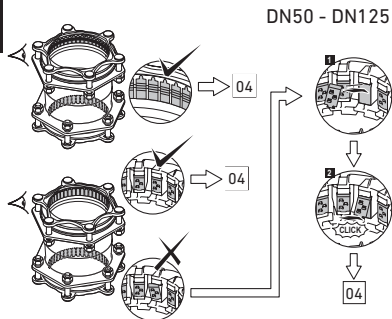

D Sicherstellen, dass alle Fikser richtig positioniert sind.

NL Controleer de juiste positie van de "Fiksers".

F Assurez-vous que les "Fiksers" (les mors métalliques) sont correctement positionnés.

NO Kontrollert at "Fikserne" er i riktig posisjon.

SE Kontrollera om "Fiksers" position är korrekt.

DK Kontrollert om "Fikernes" placering er korrekt.

FIN Tarkista "Fikseri", että asento on oikein.

PT Ver se a posição dos "Fiksers" é correto.

ES Revise si los "Fiksers" se encuentran en la posición correcta.

IT Controllare gli inserti antisfilo "Fiksers" sono OK.

GR Ελέγξτε αν τα εξαρτήματα αγκύρωσης που διαθέτει ο σύνδεσμος "Fiksers" έχουν αγκυρώσει σωστά πάνω στον αγωγό.

CZ Zkontrolovat správnou polohu fixerů.

HU Ellenőrizze, hogy a "Fikser"-ek megfelelő helyzetben vannak-e.

RO Se verifica dacă poziția elementelor de fixare "Fiksers" este corectă.

PL Sprawdzić poprawność ułożenia blaszek.

RUS Убедиться в правильности установки "Fiksers" (металлических фиксаторов).

04

**REMOVE ALL RUST, DIRT, BURRS, DAMAGES AND ALL FINISHING LAYERS FROM THE PIPE.
INSTALL ON MEDIUM CARRYING PIPE MATERIAL ONLY.**

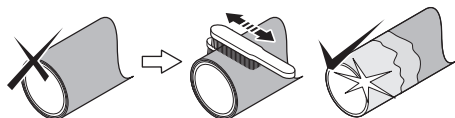
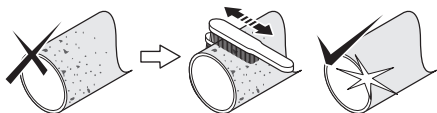

D Von der drucktragenden Rohroberfläche allen Rost, Grat, Schmutz, Schäden und alle Beschichtungen entfernen.

NL Verwijder alle roest, vuil, bramen, beschadigingen en buislagen. Monteer alleen op de mediumvoerende buis.

F Éliminez la rouille, la saleté, les bourrelets de soudures, les défauts de surface et toutes les couches de finition du tube. Assemblez seulement sur le matériau principal du tube.

NO Fjern all rust, løs overflate samt skader på materialet og overflatebehandling.

SE Avlägsna all rost, smuts, grader och eventuell ytbehandling från röret. Montera endast på mediabärande rörmaterial.

DK Fjern al rust, snavs, spåner, beskadigelser og alle belægninger på røret. Monter kun på selve det mediebærende rør.

FIN Poista kaikki ruoste, lika, taite, vauriot ja kasaumat putkesta. Asenna ainoastaan keskivahvalle putkelle.

PT Remover oxidação, suzeira, rebarbas, e revestimento do tubo.

HU Távolítson el minden rozsdát, szennyeződést, sorját, sérüléseket és minden fedőréteget a csőről. Csak közvetlenül a közeg szállító csőanyagra helyezze fel az idomot.

ES Retirar toda la suciedad, polvo, daños y etiquetas de la tubería. Montar solamente entre tubos.

IT Rimuovere sporczia, polvere, intagli e gli strati superficiali della tubazione. Il montaggio deve avvenire sullo strato a contatto del fluido trasportato.

GR Καθαρίστε όλα τα οξειδωμένα τμήματα, τις επικαθίσεις, τις παραμορφώσεις και τις υλικές βλάβες της επιφάνειας του αγωγού καθώς και τις επιστρώσεις του αγωγού μέχρι τον αγωγό μεταφοράς του υλικού.

CZ Odstranit všechny nečistoty, rez, ořepy a všechny dodatečné vrstvy z povrchu trubky. Montovat pouze na trubky určené pro transport médií.

RO Îndepartati praful, crestaturile, murdaria, defectele precum si toate straturile de acoperire de pe teava. Se monteaza doar pe materialul conductiei.

PL Usuń wszelkiego rodzaju uszkodzenia, zabrudzenia, zardzania, rdzę i wierzchnie warstwy na długości rury pokrytej przez łącznik.

RUS Удалить любые загрязнения, ржавчину, задиры и напылы, а так же покрытия с поверхности трубы. Устанавливать только на основной материал трубы.

05

ONLY GAS: USE AN (BY GEORG FISCHER) APPROVED SCRAPING TOOL. INSTALL ON MEDIUM CARRYING PIPE MATERIAL ONLY.

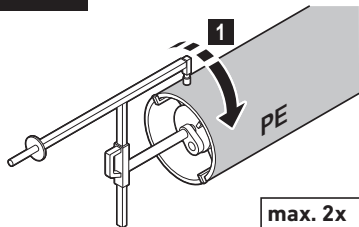

max. 2x



GAS / GAZ

- D** Für PE-Rohre ist ein Georg Fischer Schälgerät zu verwenden.
- NL** Gebruik een door Georg Fischer goedgekeurde schiller.
- F** Utilisez un grattoir mécanique approuvé par Georg Fischer.
- NO** Bruk skrapeverktøy godkjent av Georg Fischer.
- SE** Använd ett (av Georg Fischer) godkänt skrapverktyg.
- DK** Brug et (af Georg Fischer) godkendt skrabeværktøj.
- FIN** Käytä (Georg Fischer) hyväksymää karhennus työkalua.
- PT** Usar uma ferramenta (Georg Fischer) adequada.

- ES** Utilizar un rascador circular Georg Fischer.
- IT** Utilizzare in raschiatore approvato da Georg Fischer.
- GR** Αφαιρέστε όλες τις οξειδώσεις, τις ακαθαρσίες, τις παραμορφώσεις, τις αλλοιώσεις υλικού και τυχόν επιστρώσεις από την επιφάνεια του αγωγού. Αγκυρώστε αποκλειστικά επί επιφάνειας του αγωγού μεταφοράς του ρευστού.
- CZ** Použit škrabku (schválenou Georg Fischer).
- HU** Használjon (GF által jóváhagyott) hántoló szerszámot.
- RO** Se va utiliza un dispozitiv de raschetat recomandat (de GF).
- PL** Użyj skrobaka (Georg Fischer) do przygotowania rury.
- RUS** Использовать только разрешенный (компанией Georg Fischer) инструмент для зачистки.

06

CHECK TABLE FOR MIN - MAX INSERTION DEPTH.

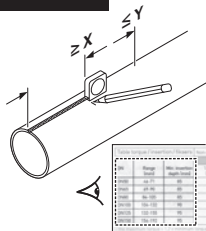

DN	X Min. insertion depth (mm)	Y Max. insertion depth (mm)
DN50	84	95
DN65	84	100
DN80	84	100
DN100	90	105
DN125	90	115
DN150	110	130

DN	X Min. insertion depth (mm)	Y Max. insertion depth (mm)
DN200	110	145
DN225	125	170
DN250	130	180
DN300	130	185
DN350	130	185
DN400	135	190



* For maximum
joint gap
information;
see our table

D Aus der Tabelle Einstecktiefe min. und max. entnehmen und auf dem Rohr markieren.

NL Zie de tabel voor de minimale insteekdiepte.

F Vérifiez sur le tableau la profondeur d'insertion correcte du tube.

NO Sjekk med tabell for korrekt innstikksdybde.

SE Kontrollera i tabellen korrekt insticksdjup.

DK Kontroller med tabellen for korrekt indstikksdybde.

FIN Tarkista taulukosta oikea asennus syvyys.

PT Ver na tabela a profundidade de inserção do tubo no acessório.

ES Ver tabla para la profundidad de inserción mínima.

IT Controllare sulla tabella la profondità di inserimento.

GR Συμβουλευτείτε τον πίνακα για την υπόδειξη του κατάλληλου βάθους εισαγωγής του συνδέσμου στον αγωγό.

CZ Zkontrolovat v tabulce správnou hloubku zasunutí.

HU Ellenőrizze a táblázatot a megfelelő betolási mélység érdekében.

RO Se verifica in tabel adancimea corecta de inserare.

PL Korzystając z tabeli określ głębokość nasunięcia łącznika.

RUS Проверить по таблице значение глубины ввода трубы (X).

07

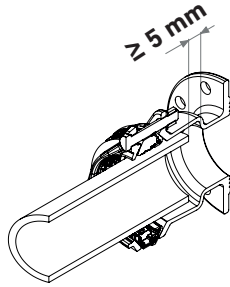
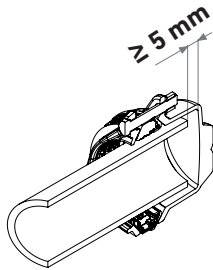
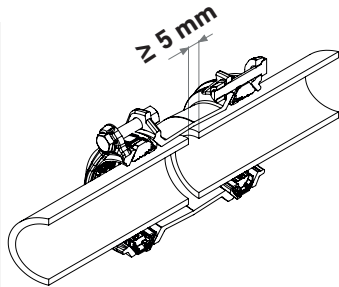
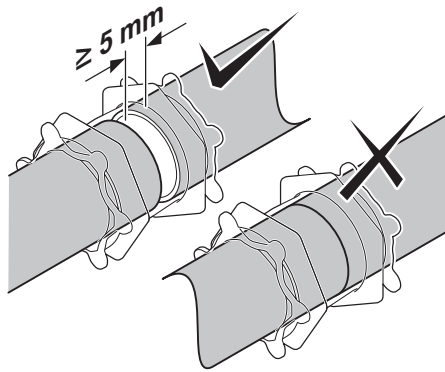

APPLY SUITABLE GREASE ON THE NBR GASKET ONLY IN GAS APPLICATIONS.

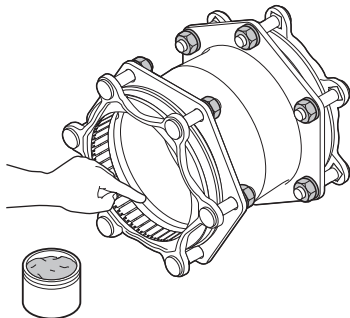

GAS / GAZ

- D** Für die Gasanwendung den Dichtungsbereich ausreichend mit Gleitmittel versehen.
- NL** Smeer de afdichting in met een geschikt glijmiddel.
- F** Lubrifiez le bague de joint avec une graisse appropriée.
- NO** Bruk egnet glidemiddel.
- SE** Applicera lämpligt smörjmedel.
- DK** Påfør egnet glidemiddel.
- FIN** Lisää soveltuva rasva.
- PT** Aplicar lubrificante adequado (nunca de origem mineral).

- ES** Aplicar la grasa correspondiente a la junta.
- IT** Applicare lubrificante opportuno.
- GR** Τοποθετήστε κατάλληλη ποσότητα λιπαντικής ουσίας στα μηχανικά μέρη του συνδέσμου.
- CZ** Aplikovat vhodné mazivo.
- HU** Használnjon megfelelő kenőanyagot.
- RO** Se aplica lubrifiant.
- PL** Nałóż warstwę smaru.
- RUS** Использовать только подходящую смазку.

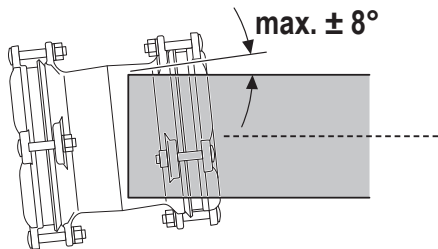

* Based on the middle of the range.

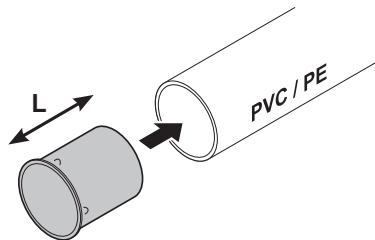

(insert approved by Georg Fischer Waga N.V.)

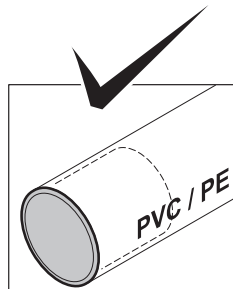

10

**MAKE SURE 'FIKSERS' (METAL GRIPPERS) ARE IN CORRECT POSITION!
FOR PE/PVC SEE WARNING ⚠.**

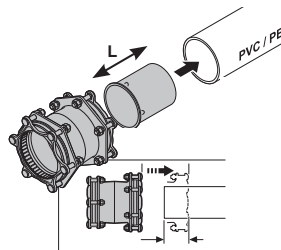
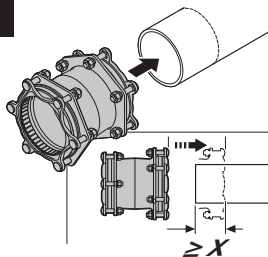

PVC / PE



$\geq x + 2,5 \text{ mm} \leq L$

D Den MULTI/JOINT 3000 Plus auf das Rohrende schieben und sicherstellen, dass alle Fikser richtig positioniert sind. Der Anpressring muss im Bereich der minimalen und der maximalen Einstecktiefe liegen.

NL Houd de "Fiksers" in de juiste positie! Bij gebruik steunbus PE/PVC: let op! Max. insteekdiepte \leq lengte steunbus (L).

F Assurez-vous que les "Fiksers" (les mors métalliques) sont correctement positionnés.

NO Ved strekkfast løsning sjekk at Fikserne er på plass.

SE Säkerställ att "Fiksers" (metal gripbleck) är korrekt positionerade.

DK Vær opmærksom på om "Fikserne" (metal-griberne) sidder korrekt!

FIN Varmista "Fikserit" (metalli puristimet) ovat paikallaan.

PT Garantir que os "Fiksers" ("grampos" de metal) estão na posição correto.

ES Asegurarse de utilizar los Fiksers adecuados en la posición adecuada.

IT Controllare che le placche antisfilo metalliche siano fissate.

GR Ελέγξτε αν τα εξαρτήματα αγκύρωσης που διαθέτει ο σύνδεσμος "Fiksers" είναι σε κατάλληλη θέση έτσι ώστε να εφαρμόσουν και να αγκυρώσουν το σύνδεσμο στον αγωγό κατά τη σύσφιξη.

CZ Zkontrolovat správnou pozici fixerů (zákusné díly).

HU Győződjön meg róla, hogy a "Fikser"-ek (fém húzásbiztosítók) megfelelő helyzetben vannak-e!

RO Se verifica dacă elementele metalice de fixare "Fiksers" sunt în poziția corectă!

PL Upewnij się czy blaszki "Fiksers" są odpowiednio ułożone.

RUS Убедиться в правильности установки "Fiksers" (металлических фиксаторов).

CHECK TABLE FOR INSTALLATION TORQUE AND PRESSURE RATING.

RESTRAINT

MULTI/JOINT®
3000 Plus
with Fikser



(S)St, DCI, GCI, AC*, GRP*, PVC, PE, PEX
Consult GF for CU, PP, ABS

DN	Torque (Nm)	MOP gas (bar)	PFA water (bar)
DN50	30	8	16
DN65	40		
DN80	60		
DN100	100		
DN125			
DN150			
DN200	120		
DN225	140		
DN250			
DN300			
DN350	140	8**	16**
DN400			

NON RESTRAINT

MULTI/JOINT® 3000
Plus
without Fikser



(S)St, DCI, GCI, AC, GRP, PVC, PE, PEX
Consult GF for CU, PP, ABS

DN	Torque (Nm)	MOP gas (bar)	PFA water (16 bar)	Torque (Nm)	PFA water (25 bar)
DN50	30	8	16	30	25
DN65	30				
DN80	40				
DN100	80				
DN125					
DN150					
DN200	120				
DN225					
DN250					
DN300	140				
DN350					
DN400					

* NO guarantee as quality varies!

** MOP 5 BAR GAS / PFA 10 BAR WATER FOR PLASTIC PIPE MATERIALS

11^b

TIGHTEN THE BOLTS WITH THE CORRECT TORQUE.

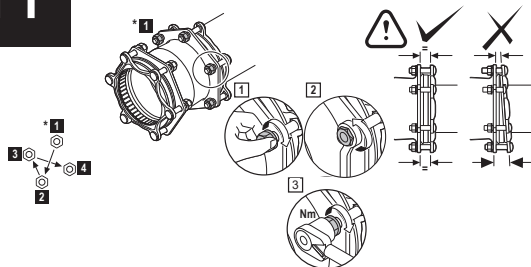

MULTI/JOINT® 3000 Plus
without Fikser



MULTI/JOINT® 3000 Plus
with Fikser

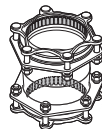

DN50-125 DN150-400

D

Der Tabelle das richtige Schraubendrehmoment entnehmen und Schrauben fachgerecht anziehen. Die Verwendung eines Drehmomentschlüssels ist zwingend erforderlich. Beim Anziehen der Schrauben ist die Einstecktiefe zu kontrollieren.

NL

Zie de tabel voor het juiste aandraaimoment.

F

Vérifiez dans les tableaux le couple de serrage à respecter.

NO

Mutrene strammes i kryss, da man skal holde samme avstand mellom koblingshus og trykkflens(gland). Etterstram med en momentnøkkel iht. Momenttabell.

SE

Kontrollera i tabell korrekt åtdragningsmoment.

DK

Det rigtige tilspændingsmoment findes i tabellen.

FIN

Tarkista taulukosta oikea vääntömomentti.

PT

Ver na tabela a força de aperto.

ES

Ver tabla para el par de apriete.

IT

Controllare la tabella per il serraggio.

GR

Συμβουλευτείτε τον πίνακα για την επιλογή της κατάλληλης στρεπτικής ροπής που θα πρέπει να εφαρμοστεί στον σύνδεσμο, κατά την διαδικασία της σύσφιξης του στον αγωγό.

CZ

Zkontrolovat v tabulce správný utahovací moment.

HU

Ellenőrizze a táblázatot a megfelelő nyomaték érdekében.

RO

Se verifica in tabel valoarea momentului de stangere.

PL

Odczytaj z tabeli odpowiedni moment dokręcania śrub.

RUS

Проверить по таблице соответствующий момент затяжки болтов.

12

≤ 0 °C ONLY ON PE PIPE UNDER FREEZING CONDITIONS, APPLY TORQUE (PRESCRIBED UNDER 11) ONE MORE TIME AFTER 30 MINUTES.

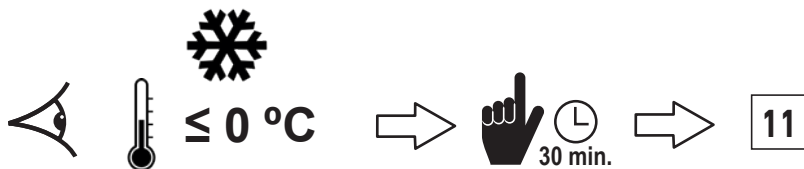

PE

D

Nur für Einsatz auf PE Röhren bei Temperaturen ≤ 0, das unter 11 ermittelte Schraubendrehmoment nach 30 Minuten noch einmal aufbringen.

NL

Alleen bij montage op PE bij temperaturen onder 0, het (onder 11) voorgeschreven draaimoment na 30 minuten nog eenmaal aanbrengen.

F

Répetez l'étape 11 après 30 minutes seulement sur des tubes en PE en temps glacial.

HU

≤ 0 °C fagypony alatti hőmérsékleten, csak PE csöveken, 30 perc elteltével újra nyomatékra kell húzni a 11. oldalon leírtak szerint.

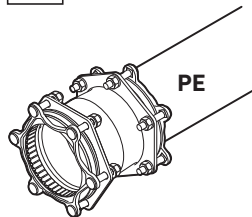

13

CONDUCT A PRESSURE TEST.

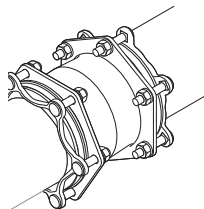

11

range	PFA gas (bar)	PFA air (bar)	PFA gas (bar)	PFA air (bar)
0-71	0	0	0	0
0-90	0	0	0	0
0-105	0	0	0	0
0-132	0	0	0	0
0-155	0	0	0	0
0-192	0	0	0	0

$$P_{\max} \leq 1,5 \times PFA^*$$

* PN25 → $P_{\max} \leq 30 \text{ bar}$

D Dichtheitsprüfung durchführen.

NL Voer een druktest uit.

F Procédez à un essai de pression.

NO Utfør trykktest på hele installasjonen, med minimum det aktuelle driftstrykk for anlegget dekket til. Trykktestingen må ikke overstige 1,5 x PFA (max arbeidstrykk) i henhold til tabellen.

SE Utför tryckprovning.

DK Gennemfør en trykprøvning.

FIN Aseta painetesti.

PT Efetuar teste de pressão.

ES Realizar un test de presión.

IT Fare test in pressione.

GR Για τον έλεγχο της στεγανότητας της σύνδεσης πραγματοποιείστε δοκιμή υπό πίεση στον αγωγό για τυχόν διαρροές.

CZ Provést tlakovou zkoušku.

HU Hajtson végre nyomáspróbát.

RO Se realizeaza un test de presiune.

PL Przeprowadź próbę ciśnieniową.

RUS Провести опрессовку.

14

PRESSURE TEST FAIL => REINSTALL FITTING. TEST OK => INSTALLATION FINISHED.

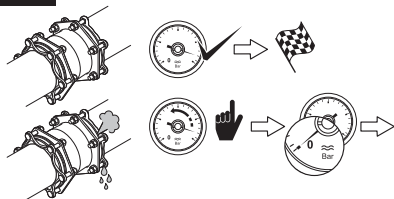

Disassembly
& Reuse

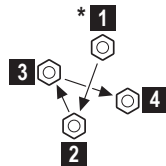

D

Falls die Dichtheitsprüfung eine Undichtheit aufzeigt, den Montagevorgang wiederholen - nach wiederholter, erfolgreicher Dichtheitsprüfung ist die Montage abgeschlossen.

NL

Druktest negatief => opnieuw installeren. Test OK => installatie gereed.

F

Mauvais résultat d'essai, réinstallez le raccord. Essai réussi, l'installation est terminée.

NO

Trykkprøving negativ => Re-installer kobling. Test OK => installasjon er utført.

SE

Tryckprovning falerar => Ommontera rördelen. Test OK => installation avslutad.

DK

Trykprøvning negativ => Re-installer kobling. Test OK => installationen er udført.

FIN

Paine testi hylätty=> asenna uudelleen. Testi OK => asennus suoritettu.

PT

Teste de pressão falhou => Voltar a instalar o acessório => Teste OK => Instalação terminada.

ES

Test de Presion Fallo => Reinstalar el accesorio TEST OK=> Instalacion completada.

IT

Se test negativo => Reinstallare. Se test positivo => Installazione finita.

GR

Σε περίπτωση που η εγκατάσταση αποτύχει και υπάρχει διαρροή στη σύνδεση => Επανα-εγκαταστήσετε το σύνδεσμο. Σε περίπτωση που η δεν παρατηρηθεί διαρροή στη σύνδεση=> η εγκατάσταση του συνδέσμου επί του αγωγού έχει ολοκληρωθεί με επιτυχία.

CZ

Tlaková zkouška není OK => tvarovku znovu namontovat. Tlaková zkouška OK => konec instalace.

HU

Nyomás próba sikertelen => végezze el újra az idom felhelyezését. Próba sikeres => felhelyezés befejezve.

RO

Daca testul de presiune esueaza => Se reinstaleaza fittingul. Daca rezultatul testului este OK => Instalare terminata.

PL

Nieudana próba => Ponowny montaż łącznika. Udana próba => montaż zakończony.

RUS

Опрессовка не пройдена => Установить фитинг снова. Опрессовка пройдена => Установка завершена.

MULTI/JOINT® 3000 Plus 2"-16"

User Manual **EN**

Manuel d'instruction **F**

Manual de instalacion **ES**



Georg Fischer Waga N.V.
Lange Veenteweg 19, 8161 PA, Netherlands
P.O. box 290, 8160 AG Epe, Netherlands
T +31 (0) 578 678 378 / F +31 (0) 578 620 848
waga.ps@georgfischer.com
www.waga.nl / www.multijoint.nl

© Georg Fischer Waga N.V.
2023, produced in the Netherlands

OUR WEBSITES

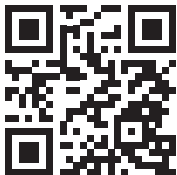

01

CHECK TABLE IF CHOSEN FITTING MATCHES PIPE OD.

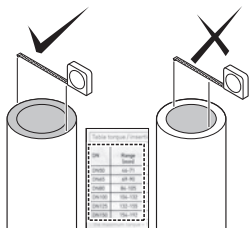

Nominal size (inch)	Range (inch)	Nominal size (inch)	Range (inch)
2	1.811-2.795	8	7.559-9.133
2½	2.480-3.543	9	9.050-10.551
3	3.307-4.133	10	10.500-12.204
4	4.094-5.196	12	12.401-14.015
5	5.196-6.102	14	13.858-15.472
6	6.062-7.559	16	15.433-17.047

F

Vérifiez sur le tableau si le raccord couvre bien le diamètre extérieur du tube.

ES

Ver tabla anexa para unir distintos diámetros exteriores.

02

DO NOT REMOVE OR GREASE BOLTS.

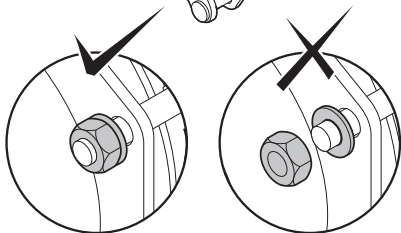
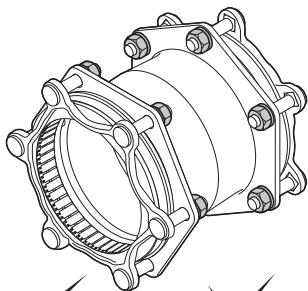

F Ne pas enlever et/ou graisser les vis.

ES No retire ni engrase los tornillos.

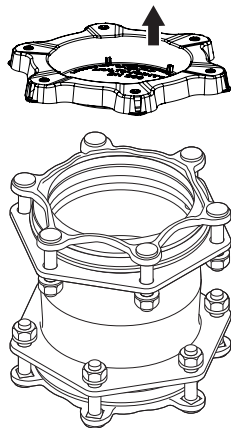

03

CHECK IF "FIKSERS" (METAL GRIPPERS) POSITION IS CORRECT.

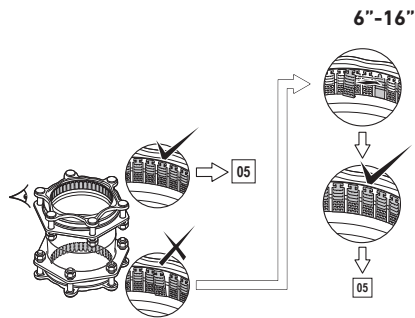
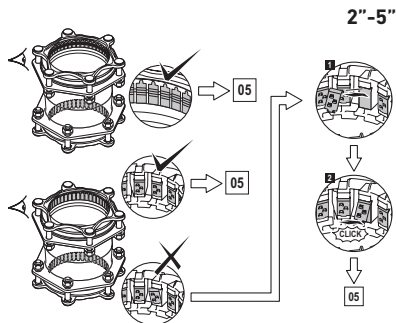

F

Assurez-vous que les "Fiksers" (les mors métalliques) sont correctement positionnés.

ES

Revise si los "Fiksers" se encuentran en la posición correcta.

04

**REMOVE ALL RUST, DIRT, BURRS, DAMAGES AND ALL FINISHING LAYERS FROM THE PIPE.
MOUNT ON MEDIUM CARRYING PIPE MATERIAL ONLY.**

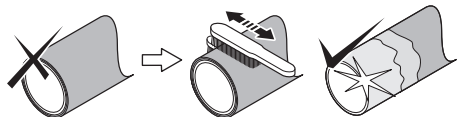
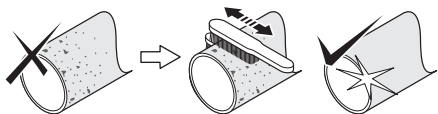

F

Eliminez la rouille, la saleté, les bourrelets de soudures, les défauts de surface et toutes les couches de finition du tube. Assemblez seulement sur le matériau principal du tube.

ES

Retirar toda la suciedad, polvo, daños y etiquetas de la tubería. Montar solamente entre tubos.

05

ONLY ON GAS. USE AN (BY GEORG FISCHER) APPROVED SCRAPING TOOL. INSTALL ON MEDIUM CARRYING PIPE MATERIAL ONLY.

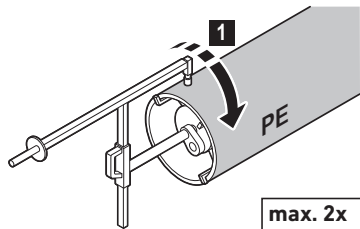

max. 2x

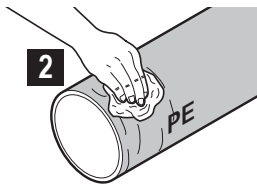

GAS / GAZ

F Utilisez un grattoir mécanique approuvé par Georg Fischer.

ES Utilizar un rascador circular Georg Fischer.

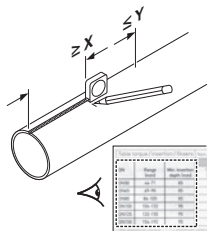

Nominal size (inch)	X Min. insertion depth (inch)*	Y Max. insertion depth (inch)*
2	3.307	3.740
2½	3.307	3.937
3	3.307	3.937
4	3.543	4.134
5	3.543	4.528
6	4.331	5.118

Nominal size (inch)	X Min. insertion depth (inch)*	Y Max. insertion depth (inch)*
8	4.331	5.709
9	4.921	6.693
10	5.118	7.087
12	5.118	7.283
14	5.118	7.283
16	5.315	7.480

* For maximum joint gap information; see our table



F

Vérifiez sur le tableau la profondeur d'insertion (X + Y) correcte du tube.

ES

Ver tabla para la profundidad de inserción mínima y máxima.

07

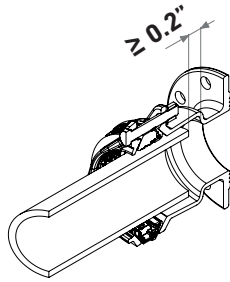
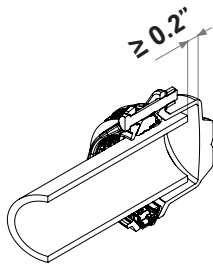
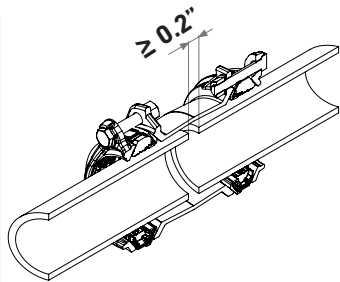
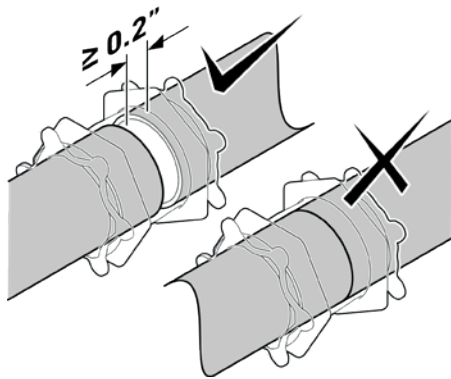

08

APPLY SUITABLE GREASE ON THE NBR GASKET ONLY IN GAS APPLICATIONS.

GAS / GAZ

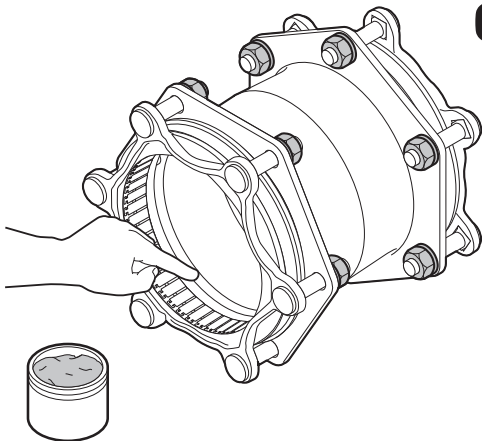

F Lubrifiez le bague de joint avec une graisse appropriée.

ES Aplicar la grasa correspondiente a la junta.

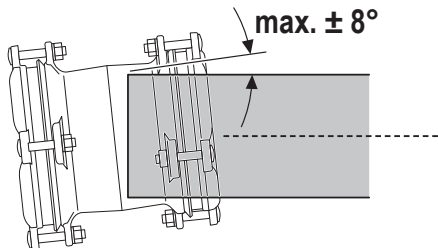

* Based on the middle of the range.

F * Basé sur le milieu de gamme.

ES * Basado en el medio de rang.

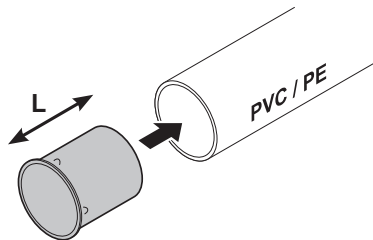

Insert approved by Georg Fischer Waga N.V.
PVC C900/909 > SDR21

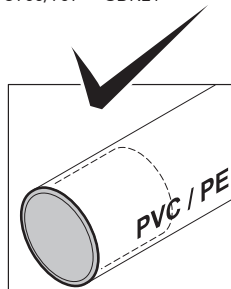

10

MAKE SURE "FIKSERS" (METAL GRIPPERS) ARE IN CORRECT POSITION!
FOR PE/PVC SEE WARNING ⚠️.

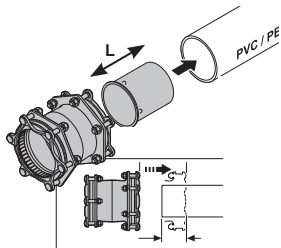
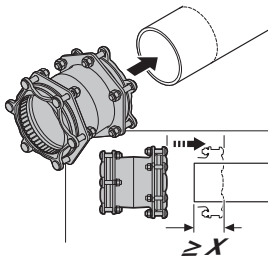

PVC / PE



$\geq x + 0.1" \leq L$

F

Assurez-vous que les "Fiksers" (les mors métalliques) sont correctement positionnés.

ES

Asegurarse de utilizar los Fiksers adecuados en la posición adecuada.

CHECK TABLE FOR INSTALLATION TORQUE AND PRESSURE RATING.

RESTRAINT

MULTI/JOINT®
3000 Plus
with Fikser



NON RESTRAINT

MULTI/JOINT® 3000
Plus
without Fikser



(S)St, DCI, GCI, AC*, GRP*, PVC, PE, PEX
Consult GF for CU, PP, ABS

Nominal size (inch)	Torque (ft-lbf)	Pressure gas (psi)	Pressure water (psi)
2	20	116	232
2½	30		
3	45		
4	75		
5			
6			
8	90		
9			
10	100		
12			
14	100	116**	232**
16			

(S)St, DCI, GCI, AC, GRP, PVC, PE, PEX
Consult GF for CU, PP, ABS

Nominal size (inch)	Torque (ft-lbf)	Pressure gas (psi)	Pressure water (psi)	Torque (ft-lbf)	Pressure water (psi)
2	20	116	232	20	362
2½	20				
3	30				
4	60				
5					
6					
8	90				
9					
10	90				
12					
14	90	100			
16					

* NO guarantee as quality varies!

** PRESSURE 75 PSI GAS / PRESSURE 150 PSI WATER FOR PLASTIC PIPE MATERIALS

11^b

TIGHTEN THE BOLTS WITH THE CORRECT TORQUE.

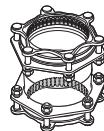
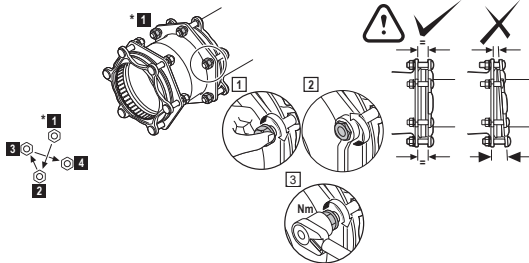

MULTI/JOINT@ 3000 Plus
without Fikser

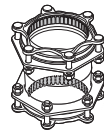

MULTI/JOINT@ 3000 Plus
with Fikser



F Vérifiez dans les tableaux le couple de serrage à respecter.

ES Ver tabla para el par de apriete.

12

≤ 32 °F ONLY ON PE PIPE UNDER FREEZING CONDITIONS, APPLY TORQUE (PRESCRIBED UNDER 11) ONE MORE TIME AFTER 30 MINUTES.

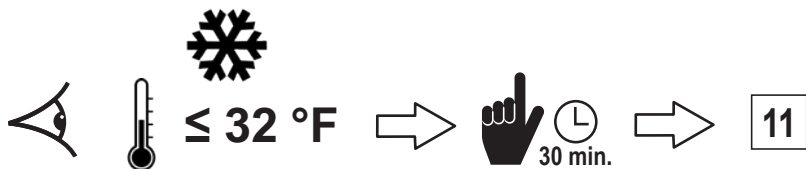

PE

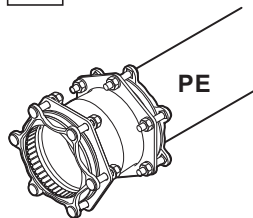

F Répétez l'étape 11 après 30 minutes seulement sur des tubes en PE en temps glacial.

ES ≤ 32 °F Solo en la tubería de PE en condiciones de congelación aplique el par de apriete (prescrito en el punto 11 una vez más después de 30 minutos).



13

CONDUCT A PRESSURE TEST.

max = 1.5 x PFA

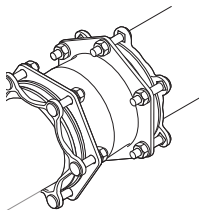
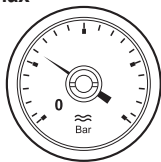

11

High	PFA	4	PFA	P
end	gas	bar	gas	wa
	(bar)	g	(bar)	lb
0-71	0	0	0	
0-90	0	0	0	
0-120	0	0	0	
0-132	0	0	0	
0-155	0	0	0	
0-192	0	0	0	

* 362 psi → P_{max} ≤ 435 psi

F Procédez à un essai de pression.

ES Realizar un test de presión.

14

PRESSURE TEST FAIL => REINSTALL FITTING. TEST OK => INSTALLATION FINISHED.

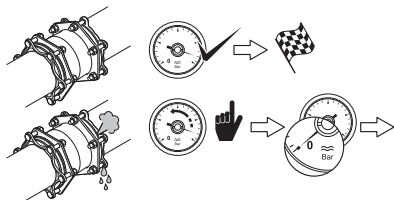

Disassembly
& Reuse

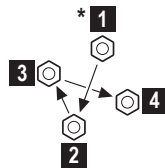

F

Mauvais résultat d'essai, réinstallez le raccord. Essai réussi, l'installation est terminée.

ES

Test de Presion Fallo => Reinstalar el accesorio TEST OK=> Instalacion completada.